



axioprisa



reddot award 2021
winner



Il gruppo forchetta digitalizzabile
The digitizable transfer fork assembly



Made in Germany

*Dove sono?
Voglio una casa!*

*Where am I?
I want a home!*

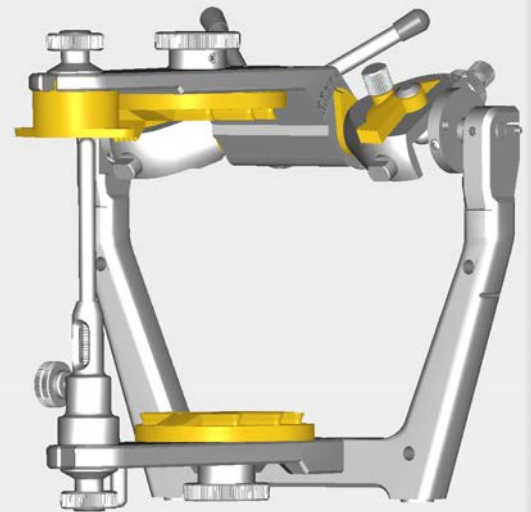
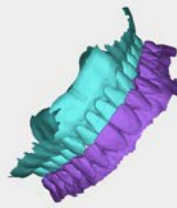

*Grazie Axioprisa!
Ora so dove stare
anatomicamente.*

*Thank you Axioprisa!
Now I know where
I am anatomical.*

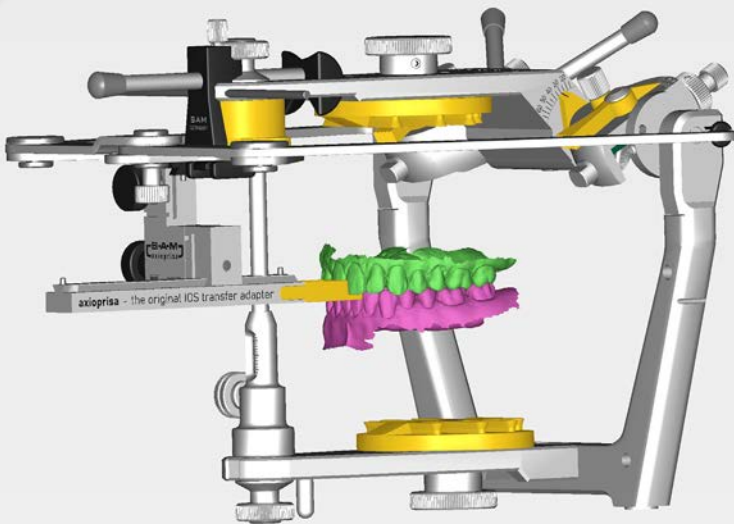

Problema: finora il posizionamento dei modelli digitali è stato mediocre, dispendioso in termini di tempo o macchinoso.

Obiettivo: il posizionamento spaziale in un sistema fisso di coordinate - corrispondente al paziente e adatto all'articolatore.

Soluzione: il primo supporto per forchetta al mondo scansionabile progettato specificamente per l'uso con uno scanner intraorale.

Vantaggio: il collaudato metodo analogico per il trasferimento della posizione del mascellare superiore nell'articolatore digitale con l'ausilio di un arco anatomico.

Conclusione: nessuna TVP, scansione di laboratorio, costoso acquisto aggiuntivo. Comprensibile.

Problem: *The allocation of digital models right now is either mediocre, time-consuming or cumbersome.*

Goal: *A steric allocation in a fixed coordinate system - corresponding to the patient and matching the articulator.*

Solution: *The world's first scannable transfer fork assembly, specifically developed for use with an intra-oral scanner.*

Advantage: *The analogue proven method for anatomical transfer of the maxillary position into the digital articulator by using the bow.*

Conclusion: *No DVT. No lab scan. No expensive additional purchases. Logically comprehensible.*

Cosa occorre
You need

- Transfer bow -
e.g. SAM Axioquick



- Arco di trasferimento -
ad es. SAM Axioquick

- Axioprisa -
scannable bite fork carrier



- Axioprisa -
supporto forchetta scansionabile

- Intraoral scanner -
e.g. 3Shape Trios



- Scanner intraorale -
ad es. 3Shape Trios

- AXP -
Axioprisa software

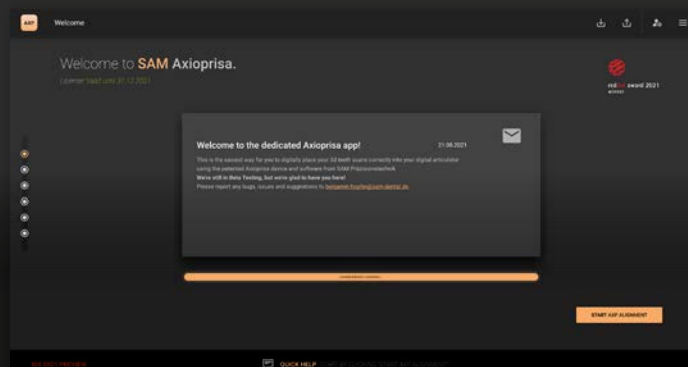

- AXP -
Software Axioprisa

applicazione
applying

scansione
scanning

accoppiamento
matching

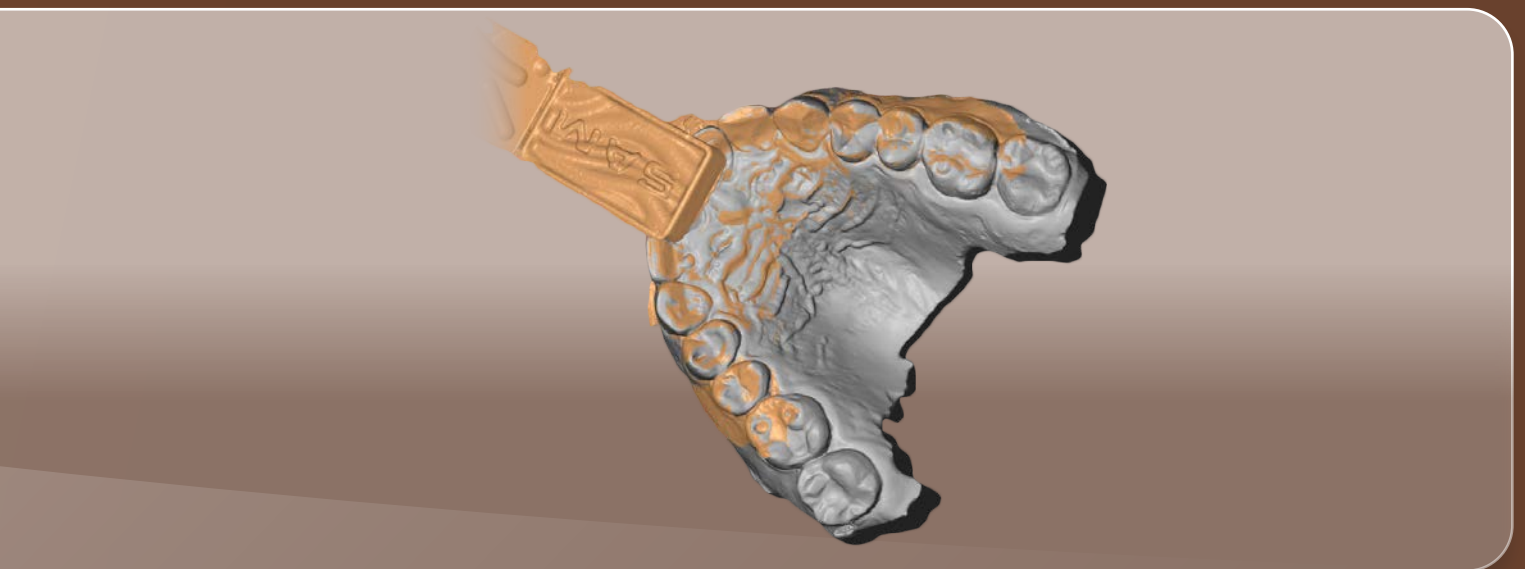
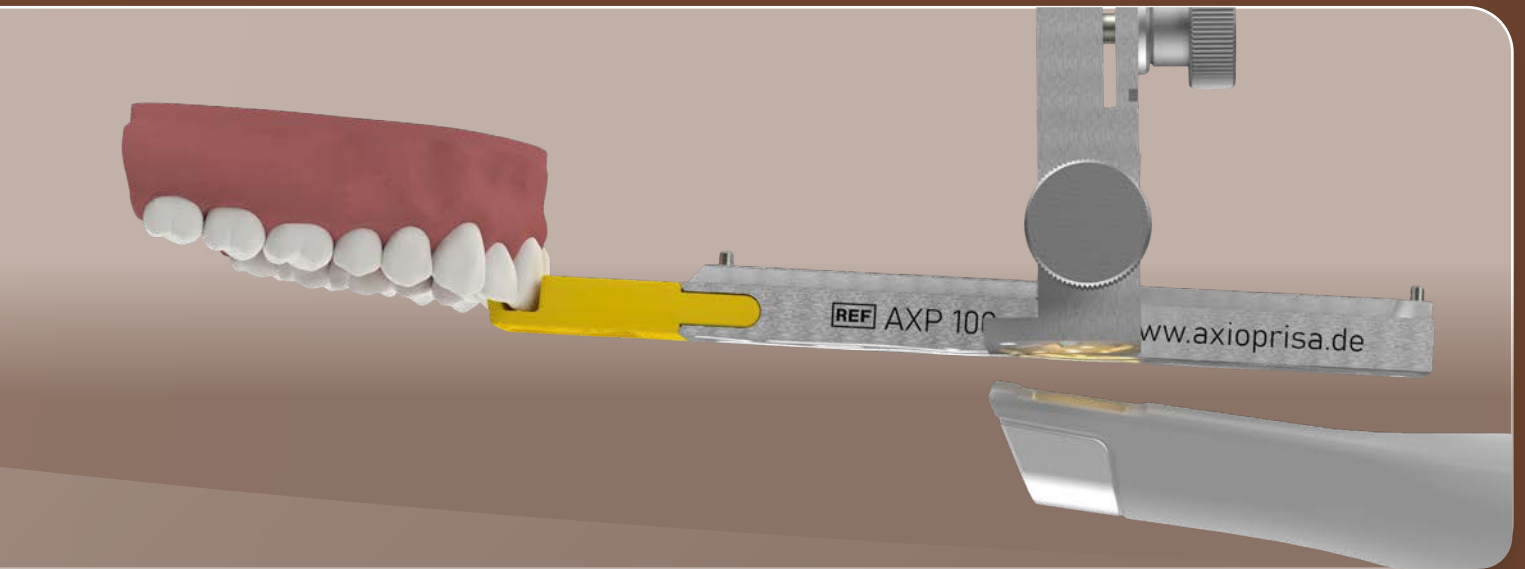
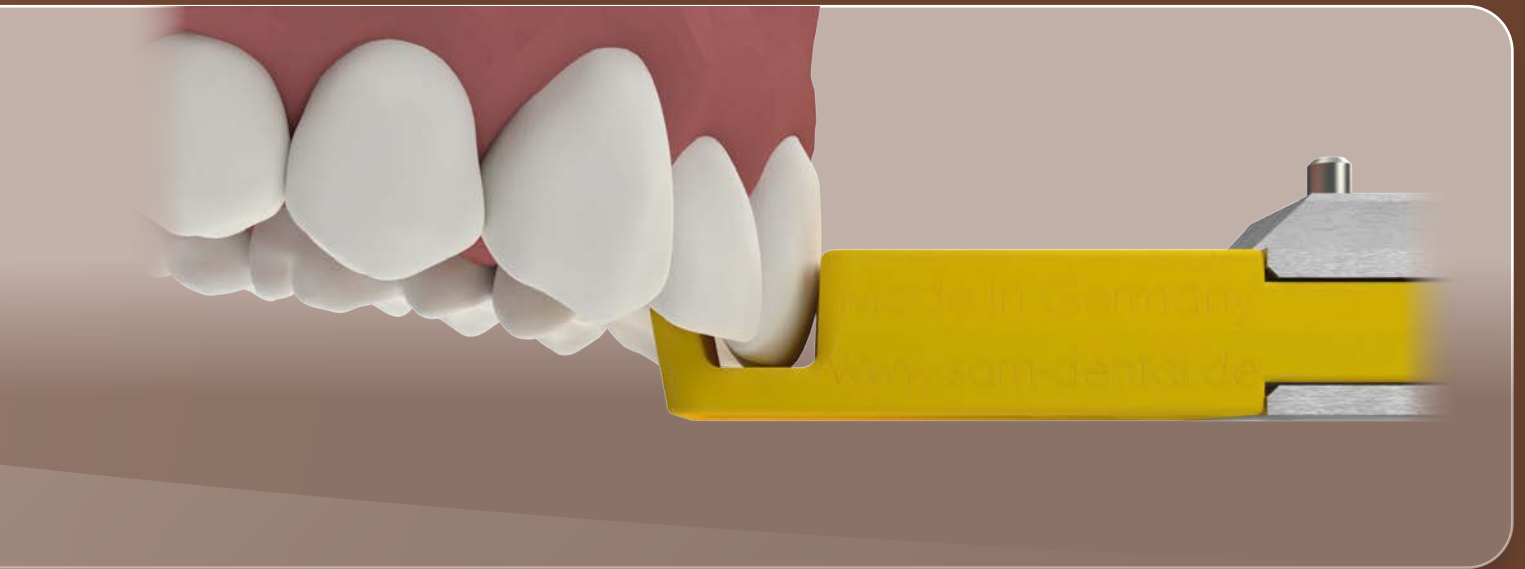

software

AXP

axioprisa

1 Importazione dei file STL / PLY / Import your STL / PLY files

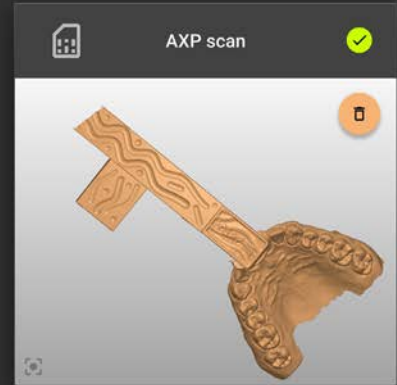
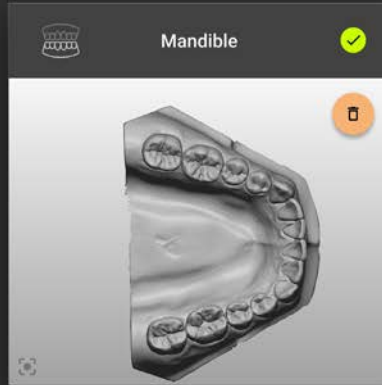
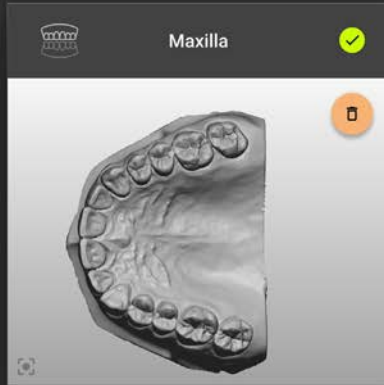

2 Allineamento della scansione AXP sulla costruzione AXP / Align AXP scan to AXP construction

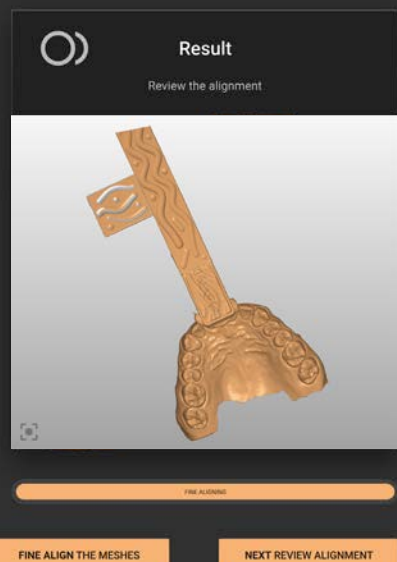
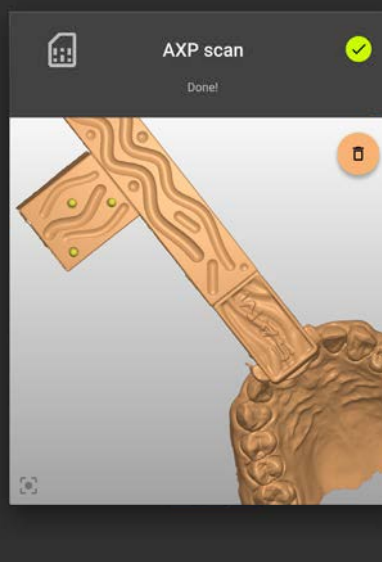
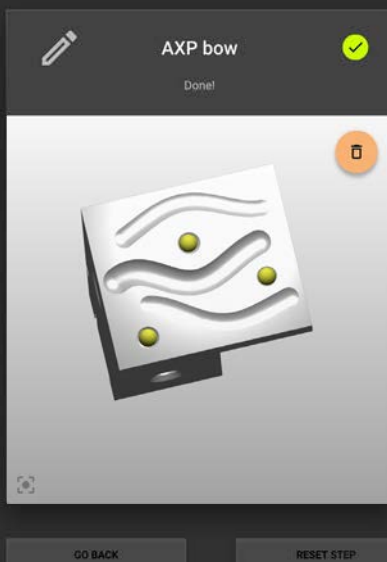

Apple & Windows
Sistema licenze per 12 / 24- mesi
Apple & Windows
License system for 12 / 24- Months



solo quattro passaggi per allineare con precisione i modelli in formato STL
only four steps to the precisely aligned model as STL file

Align maxilla scan to AXP scan / Allineamento della scansione del superiore alla scansione AXP

3

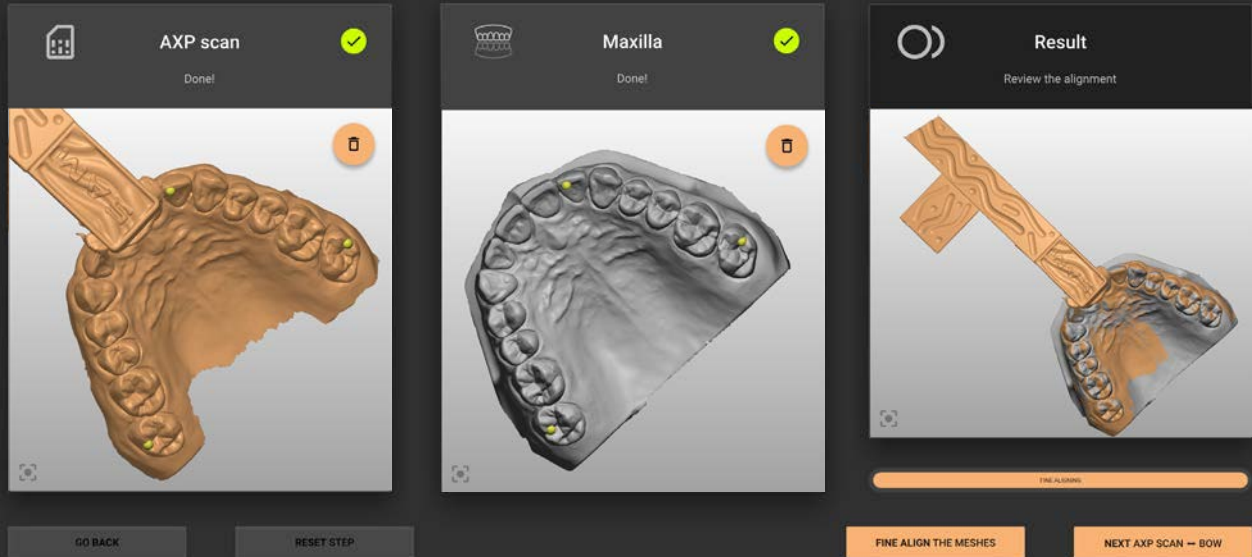

Export your AXP-aligned models / Esportazione dei modelli AXP allineati

4

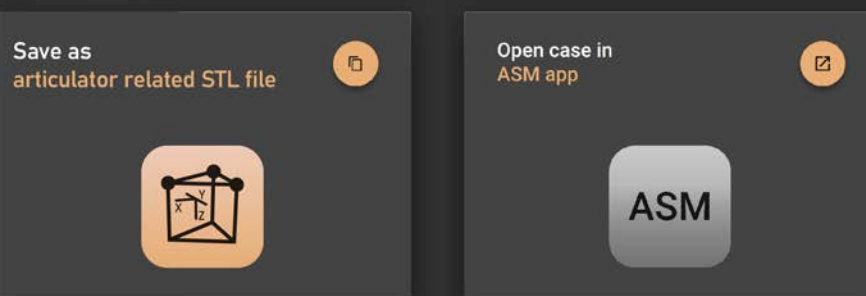

www.axioprisa.com

DIGITALE

Scansione dell'arcata superiore e inferiore *Upper and lower jaw scan*



Digitalizzazione dei denti superiori e inferiori con una scansione intraorale

Digitization of the upper and lower teeth with an intra-oral scanner

Scansione in occlusione *Bite scan*



Digitalizzazione delle arcate in massima intercuspiazione (HIKP) o in relazione centrica (CR)

Digitization of the upper and lower jaw allocation, in maximum intercuspitation (HIKP) or centric relation (CR).

Scansione di posizionamento del superiore con Axioprisa *Maxilla positions scan with Axioprisa*



Creare un'ulteriore scansione del superiore, ad es. come scansione preliminare con 3shape Trios

Create an additional maxillary scan, e.g. as a pre-prep-scan with the 3shape Trios

Registrazione dei movimenti mandibolari con AxioQuick Recorder *Mandible movement recording with AxioQuick Recorder*



La registrazione elettronica dei movimenti mandibolari e posizione rispetto ad un piano di riferimento

The electronic recording of mandibular movements and position in relation to a reference plane.

Impronta dell'arcata superiore e inferiore *Upper and lower jaw impression*

Impronta analogica con idrocolloide, alginato o silicone per la produzione di modelli in gesso tradizionalmente collaudati



Analog impression using hydrocolloid, alginate or silicone for the fabrication of traditionally established plaster models

Registrazione dell'occlusione *Bite registration*

Per posizionare e stabilizzare la relazione dente-dente in massima intercuspidadazione (HIKP) o in relazione centrica (CR)

For positioning and stabilization of the tooth-to-tooth relationship in maximum intercuspitation (HIKP) or centric relation (CR).



Posizionamento del superiore con Axiomatic *Maxillary position with Axiomatic*

Il tradizionale e sicuro trasferimento con il gruppo forchetta a bloccaggio unico

The traditional and safe transfer with the one-clamp transferfork assembly



Registrazione dei movimenti mandibolari con Axiograph *Mandible movement recording with Axiograph*

L'originale e il sinonimo di determinazione meccanica dell'asse cerniera e registrazione dei movimenti della mandibola dal 1975

The original and the synonym for mechanical hinge axis determination and recording of mandibular movements since 1975

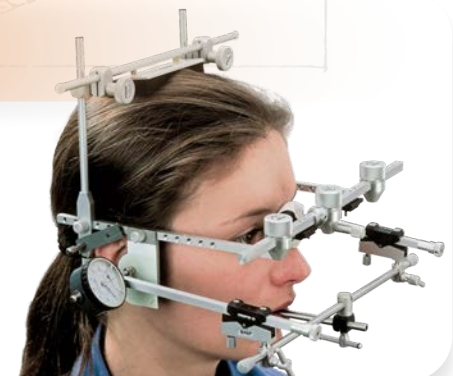

STARTER SET



1 x gruppo forchetta Axioprisa / *Axioprisa transfer fork assembly*
20 x Axiojig per forchetta / *Axiojig transfer fork*

REF AXP 100S
senza licenza software
without software license

AXIOJIG PER FORCHETTA MONOUSO IN PLASTICA - CONFORMI CE & FDA
AXIOJIG AXIOJIG - DISPOSABLE PLASTIC BITE FORKS - CE & FDA APPROVED

AXIOJIG CONF. XS

REF AXP 101XS



10 pz / *Pc.*

AXIOJIG CONF. S

REF AXP 101S



20 pz / *Pc.*

AXIOJIG CONF. M

REF AXP 101M



100 pz / *Pc.*

AXIOJIG CONF. L

REF AXP 101L



500 pz / *Pc.*

KIT ARCO DI TRASFERIMENTO
TRANSFER BOW KIT

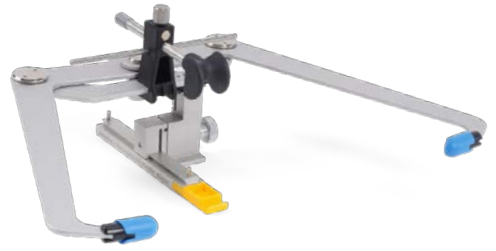

Arco di trasferimento Axioprison con 20 x Axiojig per forchetta
Axioprison transfer fork assembly with 20 x Axiojig transfer forks

Arco di trasferimento Axioprison con supporto nasale AX e 40 x copri-olive auricolari
Transfer bow Axioprison with nasal relator AX and 40 x positioning earpiece caps

REF AXP 100WK



Kit Windows
con licenza software AXP valida
24 mesi

Windows Kit
with AXP software license for
24 months

REF AXP 100K

senza
licenza software

without
software license

REF AXP 100AK



Kit Apple
con licenza software AXP valida
24 mesi

Apple Kit
with AXP software license for
24 months

LICENZE SOFTWARE
SOFTWARE LICENSES

LICENZA AXIOPRISA W12
AXIOPRISA LICENSE W12

12 mesi - Windows
12 months - Windows



LICENZA AXIOPRISA A12
AXIOPRISA LICENSE A12

12 mesi - Apple
12 months - Apple



LICENZA AXIOPRISA W24
AXIOPRISA LICENSE W24

24 mesi - Windows
24 months - Windows



LICENZA AXIOPRISA A24
AXIOPRISA LICENSE A24

24 mesi - Apple
24 months - Apple



one step ahead

SAM Präzisionstechnik GmbH

Fussbergstrasse 1

82131 Gauting

Germany

www.axioprisa.com

patents pending